

# Fabrication & Installation

RZ-801-2014

**1. Handling Safety & Storage**

- 1.1 Dimensions & Weights
- 1.2 Relocating Slabs
- 1.3 Slabs Storage

**2. Preparation**

- 2.1 Health Safety Information
- 2.2 Inspection
- 2.3 Basic Fabrication Shop
- 2.4 Tool and Accessories

**3. Templates**

- 3.1 Introduction
- 3.2 Tools Needed
- 3.3 Measurement Templates
- 3.4 Luann Strip Templates
- 3.5 Corrugated Plastic Templates
- 3.6 Digital Templates

**4. Seam Placement**

- 4.1 Planning
- 4.2 Positioning

**5. Cutting & Seaming**

- 5.1 Introduction
- 5.2 Tools Needed
- 5.3 Overview
- 5.4 Straight Cut
- 5.5 Seaming

**6. Lamination & Edge Detail**

- 6.1 Introduction
- 6.2 Laminations
- 6.3 Decorative Edge Profile
- 6.4 Edge Profiles

**7. Sink & Bowl Cutout**

- 7.1 Introduction
- 7.2 Cutout Using Templates
- 7.3 Procedure

**8. Cook-tops**

- 8.1 Potential Problems
- 8.2 Overview

**9. Support**

- 9.1 Countertop Support
- 9.2 Overhang Support

**10. Backsplash**

- 10.1 Introduction
- 10.2 Loose Backsplash
- 10.3 Full Height Backsplash

**11. Installation**

- 11.1 Transportation
- 11.2 Installation Site Preparation
- 11.3 Carrying & Positioning
- 11.4 Dry Fitting
- 11.5 Faucet Holes
- 11.6 Final Placement
- 11.7 Install Backsplash
- 11.8 Do's and Don'ts

**12. Repair Techniques**

- 12.1 Pits and Voids
- 12.2 Tools Needed
- 12.3 Pits and Voids Remove Procedure
- 12.4 Scratch Remove
- 12.5 Scratch Remove Overview
- 12.6 Scratch Remove Procedure

**13. Care and Maintenance**

- 13.1 Care and Maintenance
- 13.2 Removing stains

# 1. Handling Safety & Storage

RZ-801-2014

## 1.1 Dimensions & Weights

Never rush when attempting to move slabs, as it takes only a few extra minutes to get the job done correctly and safely. You must have two workers minimum to relocate slab(s) no matter what kind of equipment you opt to use.

### Dimension and Weight

Thickness	Size (mm)	kg/Slab	Kg/m <sup>2</sup>
12mm	1,520 × 3,100	141	30
20mm		235	50
30mm		353	75

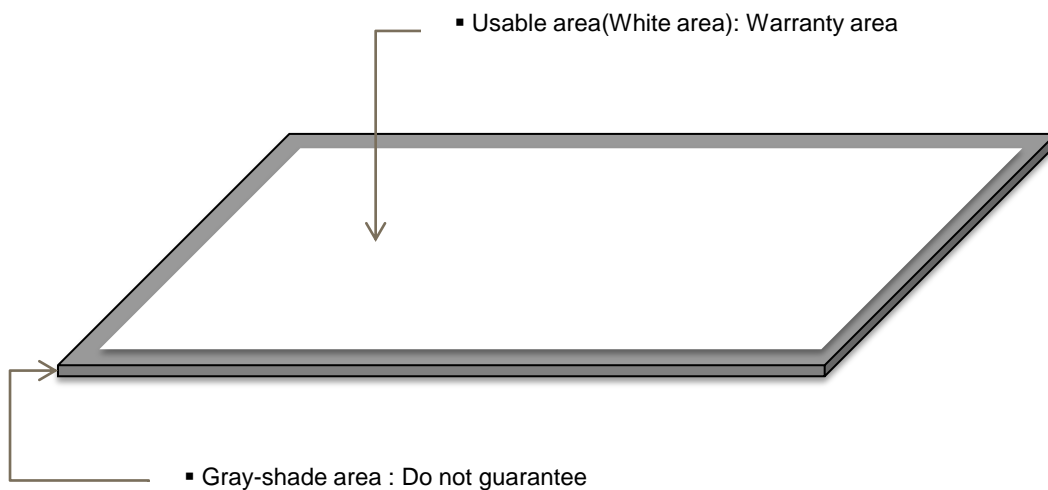

# 1. Handling Safety & Storage

RZ-801-2014

## 1.2 Relocating Slabs

Due to the nature of heavy weighted slabs, they are relocated using an overhead crane with a “C-shaped” hoist.



**Tip :** For your safety, always use common sense and follow the safety guidelines when handling Radianz<sup>®</sup> Slab(s).

Moving small pieces of slab is no less dangerous. You can use Vacuum lifter, Bear Clamps, Multi-Directional table, Tilting Carts, and skate to move them within your facility. Some of them are displayed below.

Whenever moving small pieces or a slab, extreme caution is critical to prevent a deadly incident.

Never stay under a moving slab!



RZ-801-2014

## 1.3 Slabs Storage

Indoor storage is recommended for Radianz® slabs.

If storing slabs outside is unavoidable, please be sure to have slabs kept covered and to be stored with the polished face side unexposed. (UV light from the sun can react with the plastic resins in the slabs and permanently damage the appearances or change colors. Also, rain or some contaminants may penetrate into the gap between protective film and the surface and can cause staining.)

Please note that outside storage may result in staining, discoloration, deformation, chipping, crack and many other things, thus not recommended.

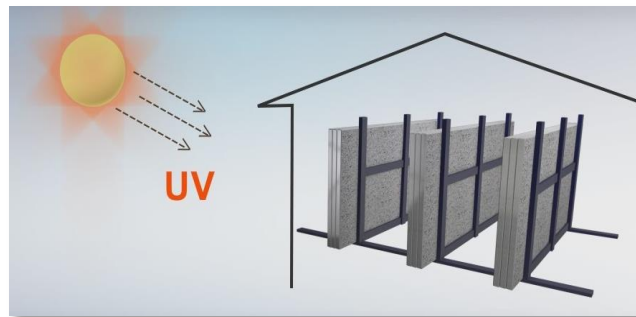

Below diagram displays how the slabs should be stored.

The first slab against the frame should be the back side and the next sequential slab should be polished face to polished face. Then the following should be back side to back side and so on.

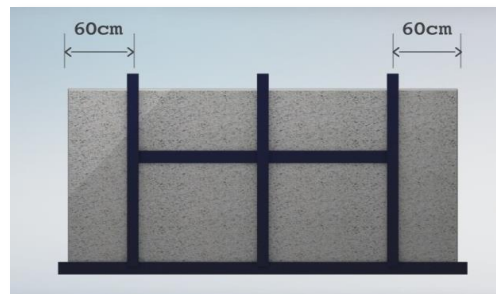
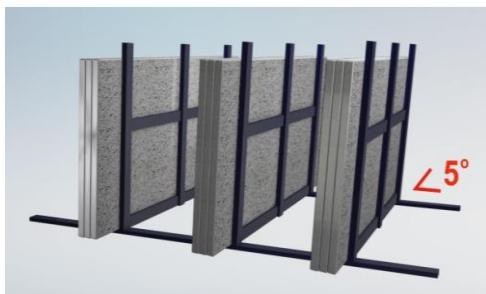

## 2.1 Health Safety Information

Information hereunder provides the most important safety issue pertaining to the fabrication and installation. Please read this carefully to understand how silica dust could cause silicosis and severely and permanently damage your health.

Quartz is a pure mineral that has the chemical formula  $\text{SiO}_2$  and is crystalline and transparent in structure. Radianz® is composed of 93% quartz by weight. No inherent health risks are present in its slab form. However, respirable crystalline silica dust represents a potential health hazards when they are inhaled by a person. The silica dust are created during all operations done dry such as sawing, sanding, drilling or routing. Dry sweeping can also create silica dusts and cause for developing to silicosis.

Overexposure of silica dust can cause silicosis by the formation of scar tissue in the lungs. Silicosis can be disabling, nonreversible and sometimes produce fatal lung disease. Symptoms of silicosis include coughing, difficulty in breathing and progressive impairment of lung function.

Shop operation in a wet environment using proper ventilation and filtration systems would keep any deadly dust airborne for inhaling and prevent shop employees from potential health risks.

### Personal Protection

- Wear safety glasses
- Wear leather or cotton gloves
- Air purifying respirator

**Note:** *All fabrication should be done wet.*

# 2. Preparation

RZ-801-2014

## 2.2 Inspection

The goal at Samsung is to provide the highest quality materials to our fabricators to insure customer satisfaction. As a result, we check and recheck each individual slab during the inspection process to meet our rigorous quality standards. In addition, it is the fabricators' responsibility to conduct a visual inspection for defects for every slab they work with. **Refer to the "Radianz® Product Non-Conformity"**

Please remove the protective film before fabricating. If you do not remove the protective film before fabrication, it may leave water marks from fabrication.

### Check List for Visual Inspection(prior to fabrication)

- Slab-to-slab color match
- Color consistency within slabs
- Holes
- Blotches (Irregular spot)
- Hair crack
- Foreign material
- Thickness
- Polishing mark
- Deformation(warpage) : Deformation should be checked using a full-length straight-edge when the slab is placed horizontally.

**Tip :** The fabricator should contact their distributor for any defect found on the slabs if it will increase fabrication time. Your authorized distributor will answer any question and provide assistance on Radianz® slabs. If you are unsure of the quality of the material, please contact your distributor for service.

**Note :** Samsung will replace the slab that does not meet the product specification. However, Samsung will not be responsible for any labor charges incurred for fabrication done on the defective materials.

### General Installation

1. Be sure to check the sequence numbers on the slabs upon delivery of the product for the best color-consistency.
2. The tops of the cabinets must be flat and true to within 1/8"(3mm) of a flat surface for every 118" (3m) length.
3. To prevent bonding failure, clean the sides or edges with denatured alcohol before applying adhesive.
4. Allow 1/8" (3mm) minimum clearance between countertops and walls for every 118"(3m).
5. Never install mechanical fasteners(screws, nails, etc.) directly into the Radianz® surface.
6. Support overhangs exceeding 12"(300mm) for 3/4"(20mm) thickness Radianz® materials.
7. Radius all inside corners to a minimum of ¼" (6mm) radius for one-piece L-shape, U-shape, etc. tops to reduce corner stresses. However, 2-piece L-shaped tops and 3-piece U-shaped tops with seams do not need to have an inside corner radius.
8. Remove all stain marks using suitable cleanser. Refer to "Care and Maintenance guide".
9. Seams going through any cutouts are not recommended. It is acceptable for the drop-in sink cutout but still it is not recommended considering the aesthetic matter of visible seam.
10. Use only approved 2-part epoxy, polyester or acrylic adhesives.
11. Avoid 'Stress Risers', (defined as a notch, gap, or sharp angled inside corner and straight edge profile). Stress risers weaken the overall performance, eventually causing a crack in quartz countertop assembly.
12. For quartz tops, Aluminum tape nor Nomex tape are not required for preventing heat damage, however, 1/8"(3mm) clearance space gap should be on all sides of the cooktop cutouts to allow for heat expansion and contraction.
13. All corners of cutouts must be round and edges smooth.

## 2.3 Basic Fabrication Shop

Similar to other industries, Radianz® fabricators vary on the brand of tools they like and use in their shops.

The following are the recommended tools to be used on Radianz® fabrications.

It is up to the fabricator to choose the brand of tools to fit their needs. However, it is very important to follow the guidelines on fabrication methods and tools that are not recommended or prohibited.

All fabrication must be done in wet operation.

## 2.4 Tools and Accessories

### 1. Slab Cutting

- Rail saw – including 12'(3.5m) and 7.5'(2.2m) rails
- Bridge Saws

### 2. Edge profiling/Polishing

- Master 3500 (hydro/transformer) 2 variable speed
- Master 2800 (hydro/transformer) 1 speed

#### Sample bit sets for Master

- V30 (full bull-nose 30mm)
- P+F30 (Ogee 20mm on 30mm)
- A30 (half bull-nose 30mm)
- E20 #1, #2 (bevel )

### 3. Hand Tools:

- Electric wet grinder
- Electric polisher
- Pneumatic polisher
- Set of engineered stone polishing pads
- 2 – Craftsman's choice 5"(120mm) turbo blades

### 4. Drilling:

- Core bit 30mm
- Core bit 35mm
- Core bit 60mm(2½")
- Core bit 75mm(3")

### 5. Bowl Hole Cutting / Shaping / Polishing

- 5"(125mm) Cyclone curved cutting blade
- 3"(75mm) Segmented grinding wheel for grinder
- 50mm x 50mm, 50 grit brazed drum
- 3/16"(5mm) radius profiler
- Set of 50mm x 50mm polishing drums for bowls

### 6. Material Handling / Table / Carts:

- Forklift boomer
- Fabrication table on casters (kitchen processing)
- 4 – A-frame (2 sets)
- 7'(2m) 12 cup bowl support system
- Pair of carry clamps
- Slab rack
- Transport trolley
- Gorilla grip – Paralign Seam Clamps.
- 2 – hand cups 8"
- Pickup A-frame for delivery – Large

### 7. Water Filtration

- 5 bag dehydrator with sludge pump

### 8. Other Materials

- Superior – flowing quick acrylic
- Superior – knife polyester adhesive
- Color kit
- Silicon impregnator
- 5 – sink undermounter 25"(630mm)
- 1 – sink undermounter 36"(910mm)

### 9. Other Materials

- Glue on stud kits for undermount bowls
- Shims – 2 boxes of 300 tapered
- Razor blades 4 boxes, mixing sticks, gloves
- Hand cleaner – cupran
- Aerosol stone soap (2 cases of 12 cans)



# 3. Templates

RZ-801-2014

## 3.1 Introduction

Before any fabrication of Radianz® is commenced, making accurate templates that are true representation of the top will help to insure problem-free-fit during installation.

A Template is a vital and most critical part of the whole fabrication process.

Installation will be problem free if your templates are perfect and fabricated according to the templates.

There are many different ways of making the templates. It is totally up to you to choose the one that best suits your business.

When deciding placement of seam lines on the template, discuss them with the customers.

## 3.2 Tool Needed

- Hot glue gun
- Glue stick
- Utility knife
- Tape measure
- Straight edge
- Level 2', 4', 6' (50mm, 100mm, 150mm)
- Paper and pencil
- Magic marker
- Template material (depending on the templating method)
  - Measurement template
  - Luann
  - Corrugated plastic
  - Digital Template Equipment

# 3. Templates

RZ-801-2014

## 3.3 Measurement Templates

This method is occasionally used by fabricators. However, this method takes the longest.

You need to spend more time and only acceptable to take accurate measurements to make sure the finished countertop fits with minimal fitting.

Arrows represent the least measurements required to proceed with this method.

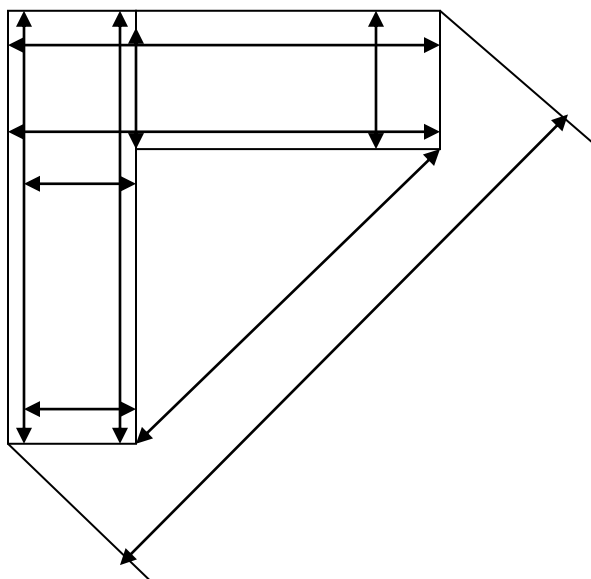

**Tip:** As you create your templates, choose the method you are most comfortable with. Measurement template method is not recommended but you could use this method for a very simple one, such as island top and etc.

## 3.4 Luann Strip Templates

3mm Luann is ripped to specific width depending on the overhang you desire.

### Example

- 30mm overhang
  - cut the strip to 50mm wide
  - 50mm strip = 30mm overhang + 20mm cabinet frame
- 40mm overhang
  - cut the strip to 60mm wide
  - 60mm strip = 40mm + 20mm cabinet frame

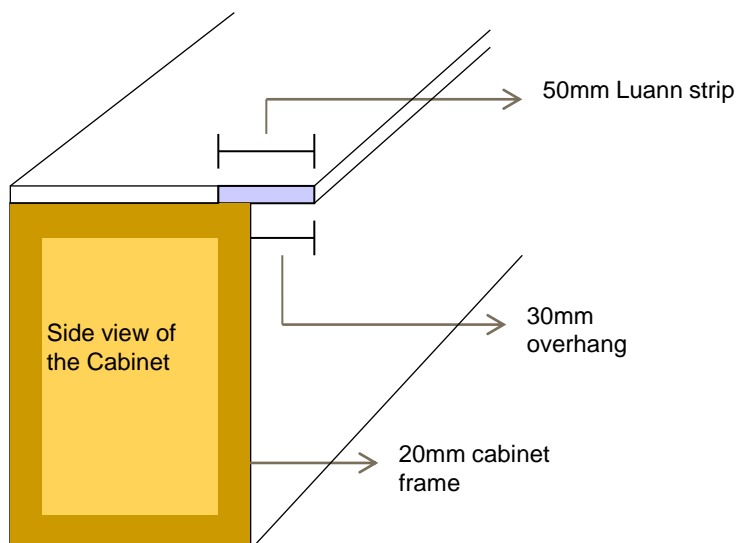

**Note:** Some people will make the template flush with the front of the cabinet and add the overhang later. Be reminded that the simpler the template to fabricate the less mistakes made throughout.

# 3. Templates

RZ-801-2014

Make sure you have enough template material on hand.

Plug in your hot glue gun.

Start laying out your strips on the cabinets as illustrated in the drawing below.

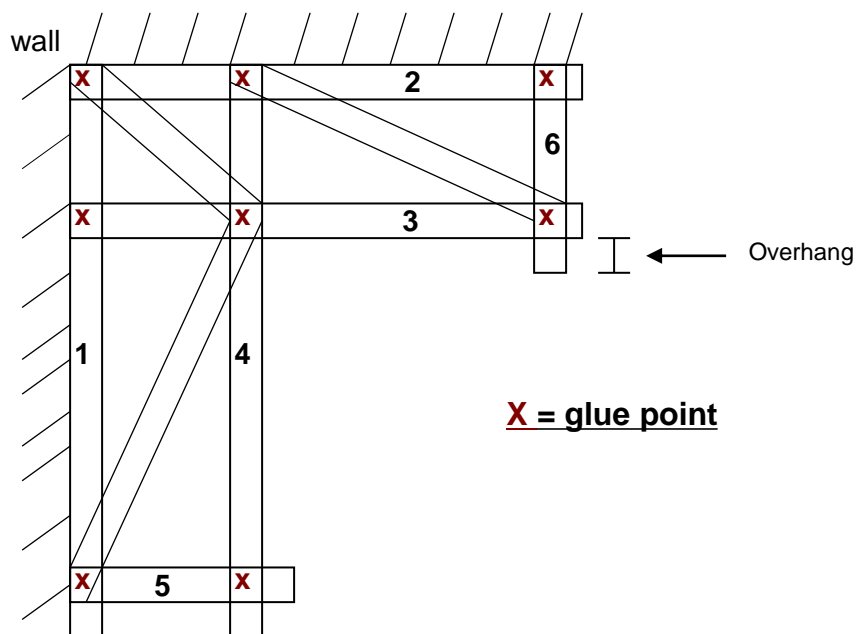

## Overview

- When the glue gun is hot, start gluing the wood pieces together.
- Do not bend the stick 1 and 2 tight to the wall, "let it float".
- Glue the sticks 3, 4, 5, and 6 tight against the wall.
- The sticks should be tight against the corner, where 1 and 2 meet.
- The points where 3, 4, 5, and 6 touch the wall will become your scribe points.
- Don't forget to mark the centers of your sink base on the template.
- Mark the center of the cooktop or any other cutouts.
- Set sticks 3, 4, 5, and 6 flush with backside of the cabinet frame for exact overhang.

### 3.5 Corrugated Plastic Templates

Advantages on why corrugated templates are good to use:

- Fits into a small vehicle (You may fold it once, but not twice!)
- Use it as a cover during installation
- Write customer information on the template

#### Overview

- 1) Place the corrugated plastic on the cabinets as illustrated in the drawing below. Overlap the pieces (overlap by 20cm – 25cm). Hot glue the pieces together.

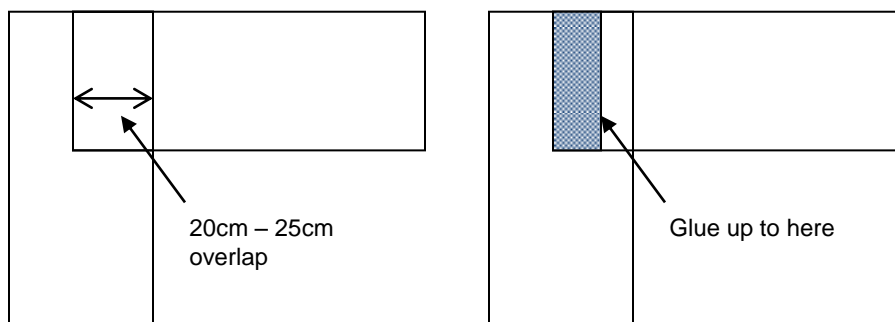

- 2) When you get the corrugated plastic to cover the cabinets, take your strips of the plastics (40mm wide strips) and glue them to form the frame as illustrated in the drawing.
- 3) These strips will give you exact measurements for scribing to the wall. If you scribe the template to the walls, you can pre-scribe the top in the shop, makes the installation go faster.

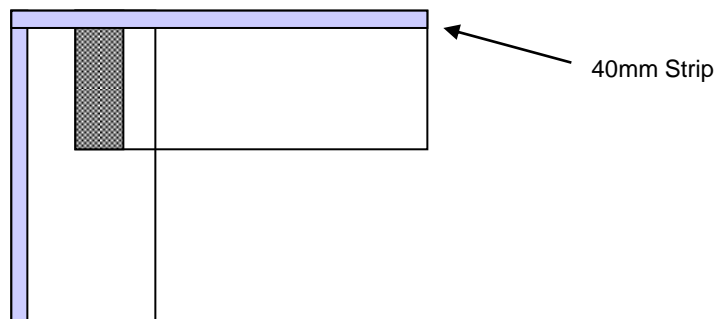

# 3. Templates

RZ-801-2014

- 4) When the template is finished, trace the front edge of the cabinets to calculate and add the overhang. Calculate the overhang you want and cut down to size. Remember to mark all centerlines of the cutouts (sinks, cooktops, etc.).

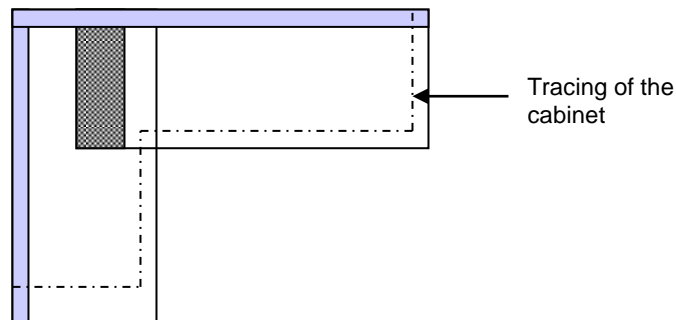

**Tip:** You may fold the corrugated plastic ONCE!

- Corrugated plastic templates will show the customers the actual size of the top. Giving them the opportunity to change the size of the overhang or other features.
- Mark all the necessary information on the template for easy access.
- Corrugated plastic templates can be used after the installation is completed to protect the countertop by covering it. This will help protect against other trades such as (painters, electrician, plumbers...) from any accidental damage the top.
- Remember, in many instances, you will be held responsible for the damage caused by other trades coming in after you.
- Protect your work by informing the customer and whatever barrier you can supply (Corrugated plastic template is a good start).

## 3.6 Digital Templates

With the advancement of technology, there are many different variety of equipments and programs to help with your templating needs. Please contact your Digital Template manufacturers for further information and instructions.

# 4. Seam Placement

RZ-801-2014

## 4.1 Planning

Careful planning is the key factor in a successful job.

When planning a job, having the right seam placement will help you minimize the use of material and time.

Remember, saving of material and time will help your business be competitive in the market.

In addition, the right seam placement will help to insure your customers to enjoy the beauty of Radianz® countertop without problems for years to come.

There should be no seams over a dishwasher!

## 4.2 Positioning

All seams recommended to be at least 150mm from any cutout.

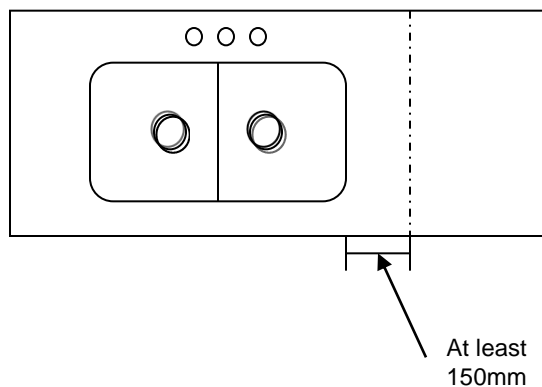

**Tip:** Discuss seam placement with customers at the time of creating a template. The characteristic of visible seams may irritate some customers if they were not informed properly.

**Note:** No seams should be directly above a dishwasher.

# 4. Seam Placement

RZ-801-2014

It is not recommended to have a seam going through a cook top! However in rare occasions, some customers insist to have a seam go through a cook top to minimize the visible seams. Please consult with a Radianz<sup>®</sup> technical service.

If the kitchen is designed where there is no other choice, please contact Radianz<sup>®</sup> technical service for advice.

With Radianz<sup>®</sup>, following inside corner seams are acceptable.

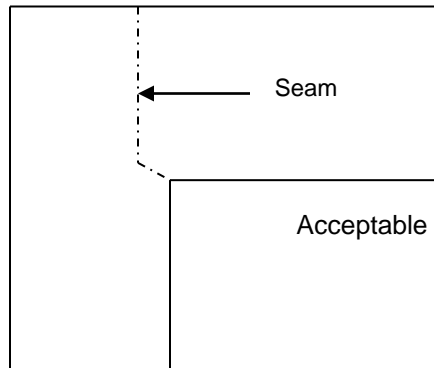
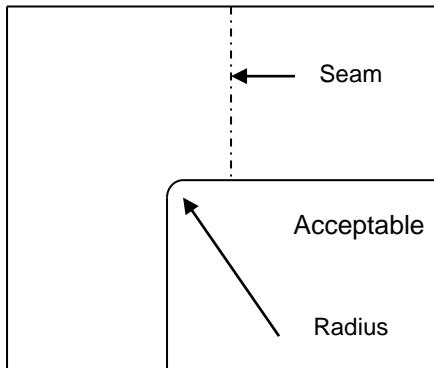
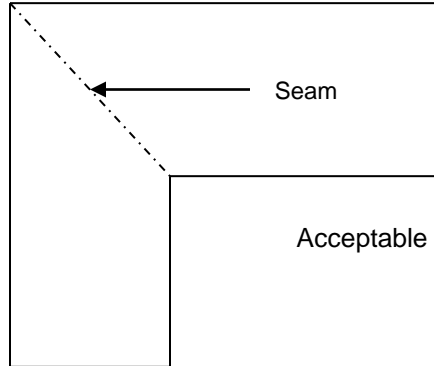
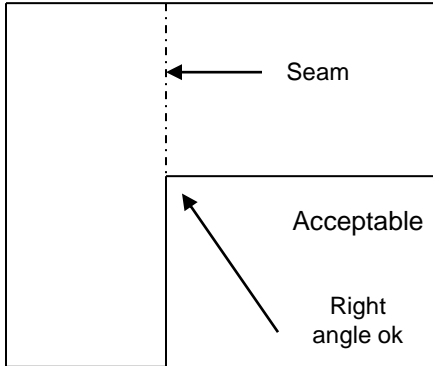



# 4. Seam Placement

RZ-801-2014

There should be no seams on an overhang of a peninsula or island.

Because of the weight of quartz and mechanical bonding strength, the overhangs with seamed joints will eventually fail.

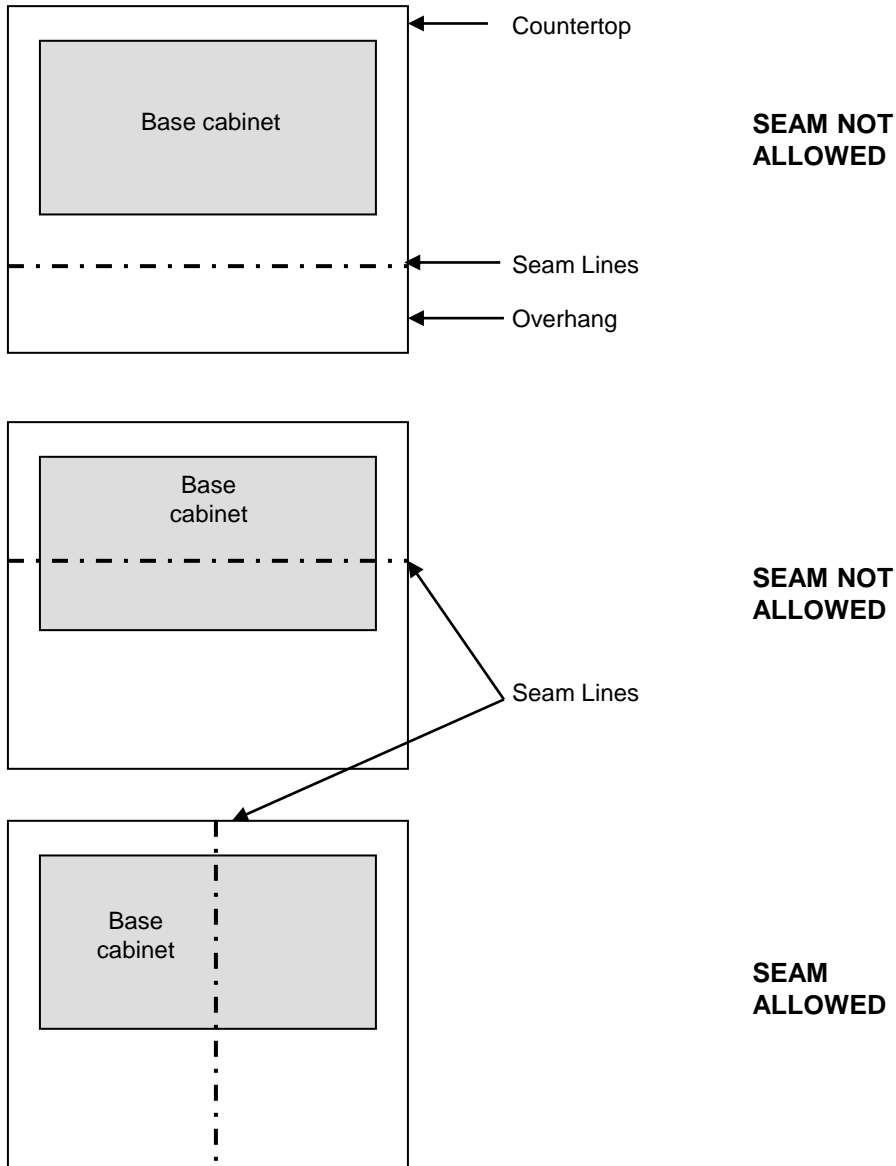

# 5. Cutting & Seaming

RZ-801-2014

## 5.1 Introduction

When planning any fabrication and installation of Radianz®, seams should be planned in a manner which minimizes the use of materials and maximize product performance. (Refer to the Seam Placement)

It is normal to waste 20%~30% of the materials when all parts are efficiently managed and cut.

Before putting seam adhesive between the two pieces to be seamed together, you need to machine the two pieces to match.

When cutting Radianz®, make sure the piece is totally supported.

## 5.2 Tools Needed

### Straight Cuts Tools

- Bridge saw
- Rail saw – including 12'(3.5m) and 7.5'(2.2m) rails (Manual cutting is not recommended )

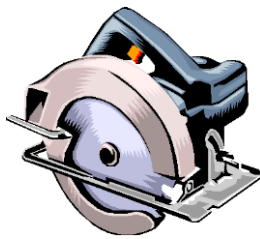

(X)



(O)

### Bowl & Cooktop Cuts Tools

- Curved cutting blade
- Segmented grinding wheel and grinder
- 3/16"(5mm) radius profiler

### Drilling Tool:

- Core bit cyclone and a grinder

### 5.3 Overview

Radius inside corners to a minimum of ¼" (6mm) will reduce corner stresses.

Two-piece L-shaped and 3-piece U-shaped tops with seams in the corners do not need to have radius corners.

Radius all top and bottom straight edge profiles to a minimum of 1.5mm radius.

Radius all outside corners to a minimum of 1/8" (3mm) radius.

**Square inside corners of any cutouts will not be covered under warranty.**

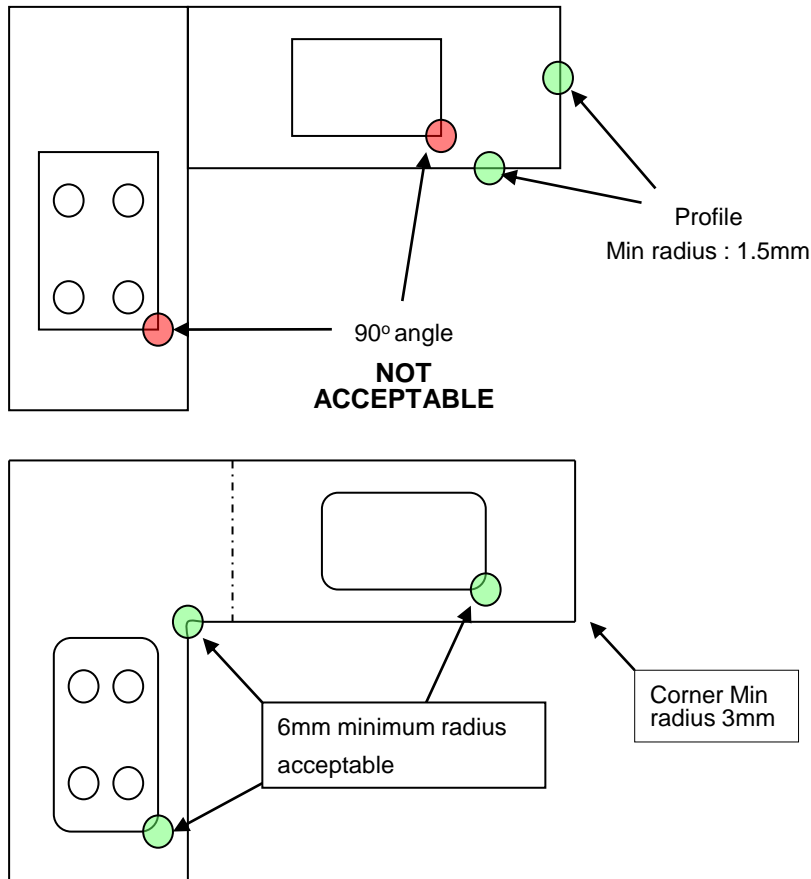

#### Recommendations for cutting Radianz® Quartz to minimize crack during fabrication:

1. Use required engineered stone blade for cutting.
2. Should not move during the cutting process when using saw blade.
3. Working table should be flat.
4. Do not plunge cut. Always start from the outside. When doing sink cut-outs or cook-top cut-outs, it is highly recommended to do such cut-outs after other necessary fabrication such as cutting.
5. Do not stop in the middle of cutting process
6. Enough water should be used at all time during cutting.
7. There should be no bevel edge cracking
8. Recommended cutting speed are as follow: THK.20 : 3m/min, THK.30 : 2m/min
9. Keep the blade sharp by running the blade through sandstone off cuts.
10. Using portable circular saw has high chance of causing crack during cutting. Cut-outs should be cut with bridge saw.

## 5.4 Straight Cut

### Straight Cut Tools

- Revolution of saw

Diameter	300mm(12")	350mm(14")	400mm(16")
Revolution	≅ 1,780rpm	≅ 1,540rpm	≅ 1,340rpm

\* The revolutions of the cutting blade can be different according to the specifications of Bridge machine and saw.

- Cutting speed : < 3.0m/min (Thickness : 20mm)  
< 2.0m/min (Thickness : 30mm)
- Cutting saw
  - Required engineered stone blade should be used.
  - Granite cutting saw : Unacceptable (Risk of crack)
  - Marble cutting saw : Partially allowed but consumption of the blade can be high.



Rail saw



Bridge machine

### Tips to remember

- Seams are visible.
- Make sure the cord does not get caught on a clamp or table.
- Do not STOP once you started the cut!
- The seam will open up and result in a bad seam if your pieces are not flat and true in the seaming process.
- Recommended seam width is < 1.5mm.
- Height mismatch of joined Radianz<sup>®</sup> field seams must not exceed 0mm.

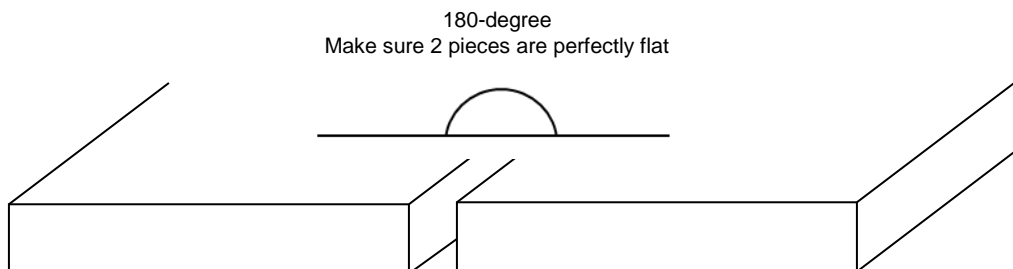

## 5.5 Seaming

After seams are cut using one of the methods introduced earlier, you will be ready to apply seam adhesives. However, before applying seam adhesives, good edge preparations are necessary to remove contaminants and improve seam performance. The keys to successful seaming are mostly in the preparation of the edges, the edges to be seamed.

### Overview

1. Surface elevation of both pieces must be exact and perfect
2. Knife grade polyester adhesives are used to seam quartz countertops

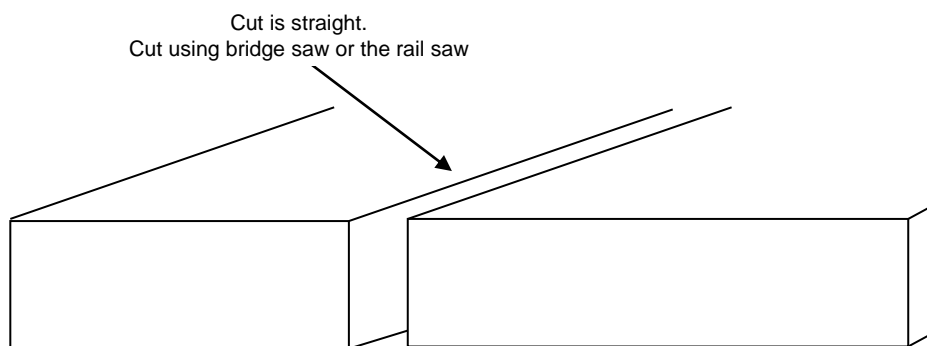

**Tip:** For the best result, clean the end to be seamed with acetone or denatured alcohol and dry completely before applying adhesives.

### Setup for seaming:

1. Put a painter's tape across a line where the seam is going to be. Most seams will be done at the field.
2. Choose a clamping method and get ready with the equipment
3. To observe the adhesive curing time, leave some squirts in a separate cup and try to stir it every 3~5 minutes until the adhesive is totally rigid. Remember, the adhesives in the quartz may need more curing time due to the temperature difference of the quartz themselves.

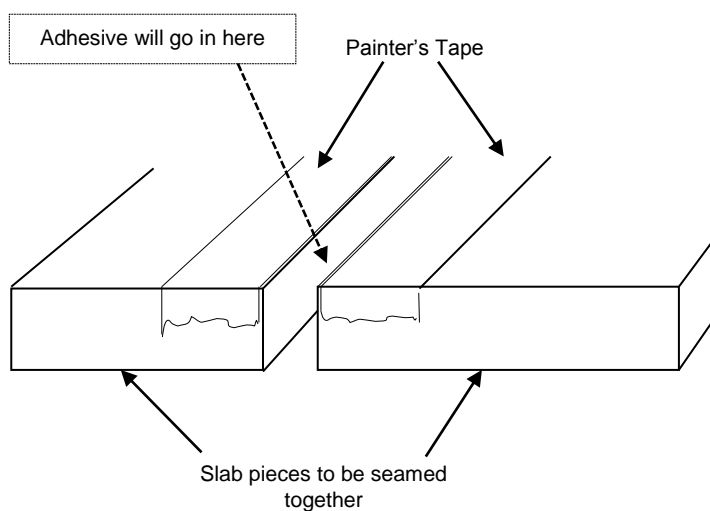

# 5. Cutting & Seaming

RZ-801-2014

## 5.5 Seaming

### Seaming Adhesive Procedure

1. Wipe the edges of 2 seam pieces down with acetone or denatured alcohol.
2. Once you wiped the material down, do not touch the pieces. The seam adhesive could pick up oils from your skin and discolor the seam and weaken the seam performance. This is common with light colored materials.
3. Put painter's tape on both sides of the slab pieces where seams going to be placed. You can easily remove adhesive residues by doing this.
4. Decide what kind of clamping method you will use to clamp the two pieces. There are different ways to clamp the pieces together such as:
  - A. Suction cups and clamps
  - B. Gorilla grip or similar clamping system (Best choice!)
5. Once you decided on a clamping method, seam adhesives can be applied.

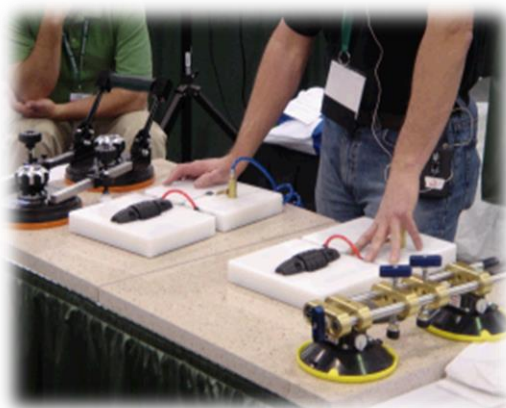

Suction cups clamps & Gorilla grip clamps

6. Pull the two seam pieces apart about 3mm
7. Pour the Radianz® color matching adhesive into the seam from the farthest end. The adhesive must be filled through the entire seam thickness.
8. Any excess can be smoothed out with a plastic spreader to insure a good fill.
9. Razor blade can be used to remove excess filler.
10. Wipe down the seam with acetone across the seam not in the lengthwise direction to eliminate the residue at the end.



# 5. Cutting & Seaming

RZ-801-2014

*Note: The pieces must be flat before seaming. Flatter the pieces are, better the seamed performance would be.*

*If tops of the cabinets are not leveled, therefore the pieces are not perfectly flat/leveled, the cabinets must be shimmed up to within 3mm of a flat surface over 3m. This must be done before applying seam adhesives.*

11. Once the seam adhesive is placed in the seam, the 2 pieces can be pulled together with whatever method of clamping method you have chosen.
12. Let the seam adhesive dry until it is as hard as the slabs themselves. This usually takes approximately 45-60 minutes, depending on the air temperature and slab temperature. The seam will dry faster when it is warmer and take longer when the temperature is cooler.

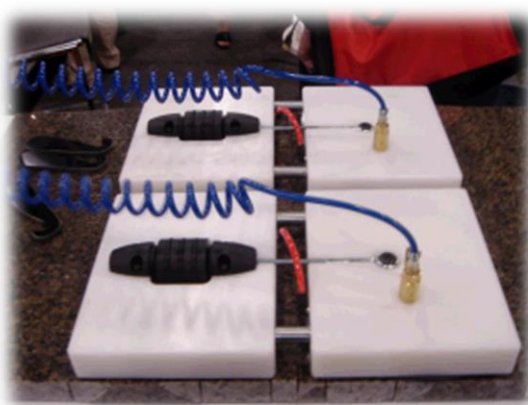

Gorilla Grip  
Clamping Method

**Note:** *The seam adhesive is cured when it is no longer wet and sticky. It should be hard to the touch.*

*IT SHOULD BE VERY HARD!*

*Some of the seam adhesive will squeeze out when the slabs are pulled together. They could be easily removed using a razor blade immediately after the clamping is in place.*

# 6. Lamination & Edge Detail

RZ-801-2014

## 6.1 Introduction

In fabricating a Radianz® countertop, you have the option to give the customer a unique edge treatment, which will look great and make the people love their countertops even more.

Lamination and edge detail is the way to buildup and decorate them with one of multiple choices of designs available.

## 6.2 Laminations

Lamination is a deck with 1 layer of  $\frac{3}{4}$ " (20mm) material stacked at the edge of countertop to give even deeper elegance look to the top.

This is usually done for the  $\frac{3}{4}$ "(20mm) materials to match the height and depth of the cabinet and no lamination is done for the  $1\frac{1}{4}$ "(30mm) thick materials.

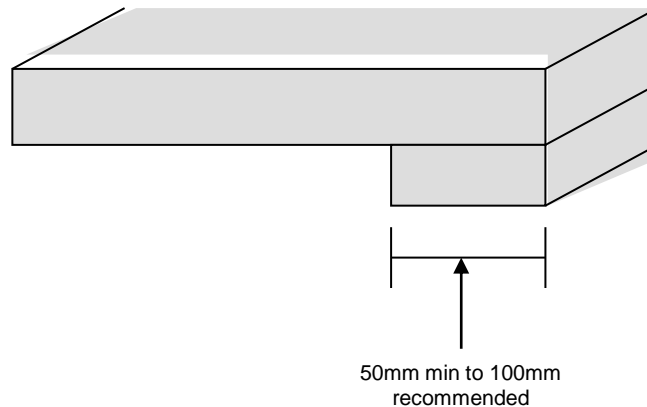

### Overview

1. When applying seam adhesive to the deck, place seam adhesive on back edge, front edge, middle where the lamination is being placed.
2. Apply approximately 3mm bead 6mm in from the front deck and in the back and the middle.
3. Using either C-clamps or Numeric clamps to tighten the lamination.
4. Clamp the lamination build-up every 80~100mm. This will give just enough clamping pressure to make the seam tight and smooth.
5. After the lamination is complete, honing of the edge is performed. (Please refer to the available edge treatments on the next page)

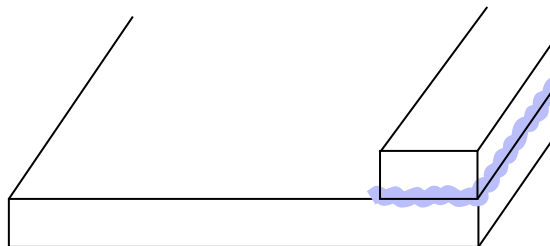

**Note:** Too much clamping can cause all the seam adhesive to squeeze out. This is called "Starving the Seam". If you starve the seam, there is a good chance of seam failure during the life of the countertop due to the lack of seam adhesive holding the materials together.



# 6. Lamination & Edge Detail

RZ-801-2014

## 6.3 Decorative Edge Profile

Decorative Edges can be added to Radianz® countertop edge profiles to add beauty and elegant style.

Remember, most of the countertops have decorative edge profile.

Following are the most commonly used edge profiles:

- 1.5mm, 3mm, 6mm, 12mm and 20mm Radius
- Bull Nose
- Bevel
- Ogee
- Customizable

**Tip :** A Comprehensive Edge detail list is provided on the following page.

The above listed profiles are routed both top and bottom of the straight profile.

Remember! The bits for ¾"(20mm), 1¼"(30mm) and 1½"(40mm) in making the edge treatments require all different tools. They are very costly and they must be considered.

**Note :** *There are many different tool manufacturers developing cutting and shaping for different edge profiling, please consult with the manufacturers for details on technical and warranty issues.*

**\*\* Samsung Radianz® will not be responsible for edge failures due to defective bit, flawed design of the edge, and other related circumstances**

# 6. Lamination & Edge Detail

RZ-801-2014

## 6.4 Edge Profiles

### Most Popular Edges



Straight



6mm Round

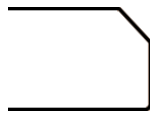

Bevel



Round T&B

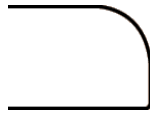

Half Bull-nose

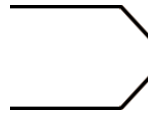

6 Bevel T&B

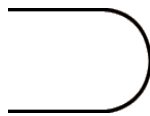

Full Bull-nose

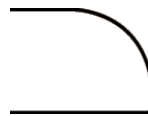

Demi Bullnose

### Premium Edges



Ogee

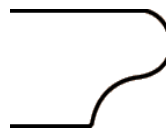

Stair Thread



Waterfall



Cove Ogee

RZ-801-2014

## 7.1 Introduction

### For a setback to a cutout

- 1 ½"(40mm) minimum from the back
- 3 ½"(90mm) minimum from the front (under mount)
- 2 ¼"(60mm) minimum from the front (drop-in)

### Recommended Tools

- Bridge saw
- Water jet
- CNC machine
- Master 6000
- Templates (usually solid surface materials)
- Clamps

## 7.2 Cutout Using Templates

Sink & Bowl cutout templates are an important part for fabricating Radianz<sup>®</sup> tops.

Sink & bowl cutout templates will save you time and materials.

It is recommended to have templates for all the Radianz<sup>®</sup> Sinks and Bowls and all other models fabricating in your shop for faster and accurate cutouts.

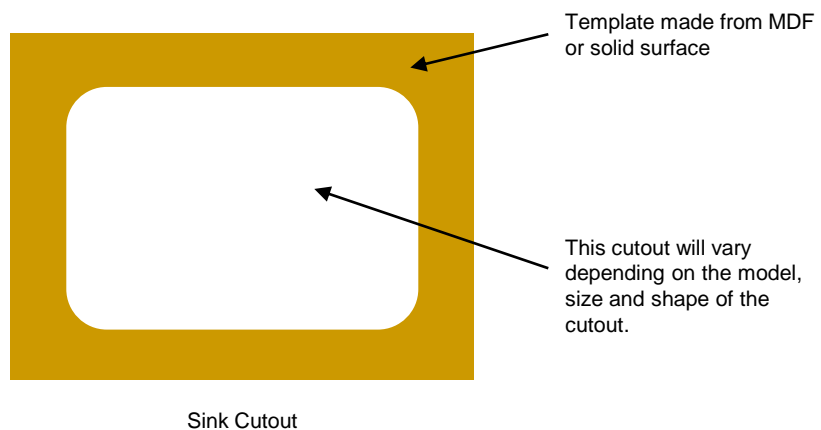

# 7. Sink & Bowl Cutout

RZ-801-2014

## 7.3 Procedure

### Procedure for Sink & Bowl Cutout

- You will need to make a wooden or solid surface template of the sink to perform cutouts. Templates could be created with CAD drawings.
- Place the template on the top and trace the inside of the sink with a white-outs. When you set the template on the sink, it should be flush to the inside of the sink.
- Remove the template and using the core bit to drill-press the four corners and use bridge saw to cut between the holes.



Wet drilling with core bit



Cutting with bridge saw



Cut-out by CNC



Cut-out by water jet

**Note :** When in need to cut-out the sink or cook-top, it is highly recommended to do cut-outs after other necessary fabrication such as cutting. Bridge saw, CNC machine and water-jet are recommended when doing cut-outs. Using Portable circular saw can cause crack during cutting.

**Tip :** Always mark your template with a centerline and the model number of the shape. Mark any/all guideline information on the template for future reference.

- When profiling with Master 3500, set it to 6000rpm. (bits #1 & #2)
- Honing (bits #3 & #4) and polishing (bits #5 & #6) should be done at 3000rpm.



Rough cutout



Master 3500 and use all bit steps

**Note :** Be careful resting the weight of the machine on top of the sink cutout top because the top with cutout has much less strength. Support under-mount sinks with brackets.

**Tip :** During honing process, the faster you move back and forth the better results you will achieve. This gives the operator less chance to bump or bounce on the straight edge profile. Keep record of how many passes are required on different colors to achieve desired gloss level. This will help in training others in the future.

# 8. Cook Tops

RZ-801-2014

## 8.1 Potential Problems

The cooktop area is the area where various problems could occur.

The following is the list of possible damage causes you should consider.

- 1) Heat – expansion and contraction. (excessive heat)
- 2) Stress riser points in the cutouts.
- 3) Faulty cooktop, dispensing too much heat.
- 4) Not enough space between the cooktop and the countertop

## 8.2 Overview

- 1) Shimming is used to support Radianz® tops. Installation purpose.
  - All corners
  - Center of back
  - Center of sides
- 2) Because of its nature of heavy weight, no shimming is recommended at the front of the cabinet. Front of the cabinets are weak.
- 3) 1¼" (30mm) need no underlayment .

## 9.1 Countertop Support

- 1) Shimming is used to support Radianz® tops and for installation purpose.
  - All corners
  - Center of back
  - Center of sides
- 2) Because of its nature of heavy weight, no shimming is recommended at the front of the cabinet. Front of the cabinets are weak.
- 3) 1 ¼" (30mm) need no laminations.

**Tip:** Front of cabinets are not fully supported and always weaker than the back the back side of the cabinet.

## 9.2 Overhang Support

### Overhang Support

- Overhangs of 12" (30cm) or less do not need to be supported for ¾" (20mm) thickness
- Overhangs of 15" (40cm) or less do not need to be supported for 1¼"(30mm) thickness

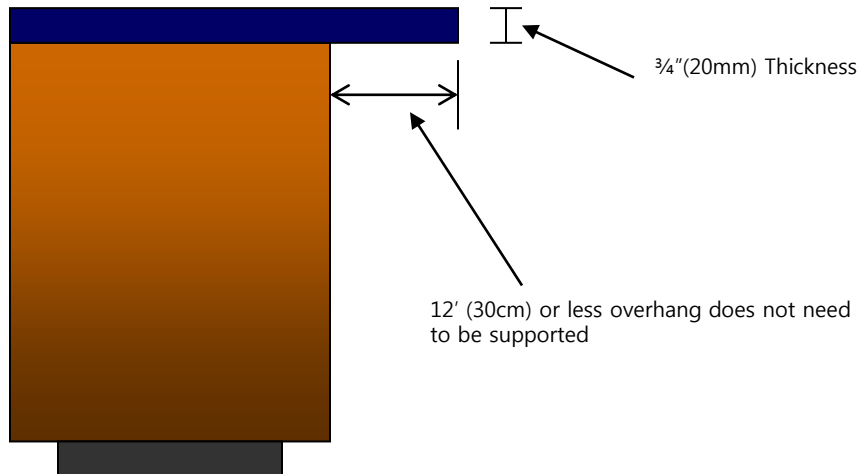

**Tip:** Corbel type of support is recommended for adding strength.

- Overhang of 12" – 18" (30~45cm) need to be supported with plywood substrate, metal frame or Corbels for ¾"(20mm) thickness.
- Overhang of 15" – 24" (48~60cm) need to be supported with plywood substrate, metal frame or Corbels for ¾"(20mm) thickness.

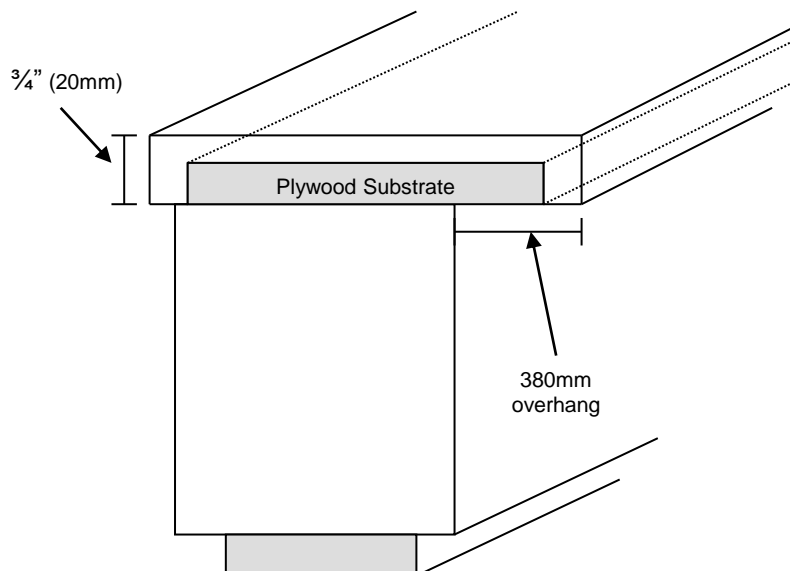

RZ-801-2014

**Overhang Support: Corbels**

- Usually made out of wood to match the cabinets, or they can be made from any other materials to match the top.
- Corbels need to be 50% longer than the width.

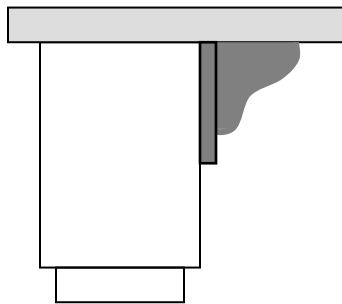

Corbel Type A

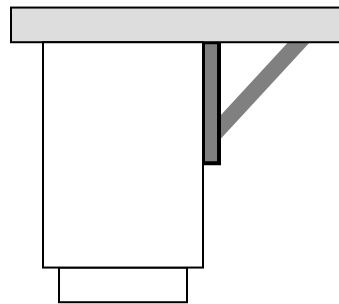

Corbel Type B

- Brackets must be installed every 600 mm(2') or less. Determine the number of brackets to fabricate by measuring the cabinet. Brackets must be long enough to reach within 127 mm(5") of the countertop edge.
- Fabricate the backer plates that will be used to mount the brackets to the cabinet.
- Drill screw holes into the backer plate every 600 mm(2') or less determined earlier to match up with the brass inserts in the brackets.
- Fasten the brackets to the backer plates using screws.
- Fasten the backer plates to the cabinet frame with wood screws before attaching the plywood underlayment.
- Use one dab of silicone adhesive every 300 mm(1') to 457 mm(1'5") to secure Radianz® worktop to the plywood underlayment.
- Use one dab of silicone adhesive 25 mm from the tip of each bracket. Apply dabs of silicone every 300 mm(1') to 457 mm(1'5") to the upper edges of the cabinets.

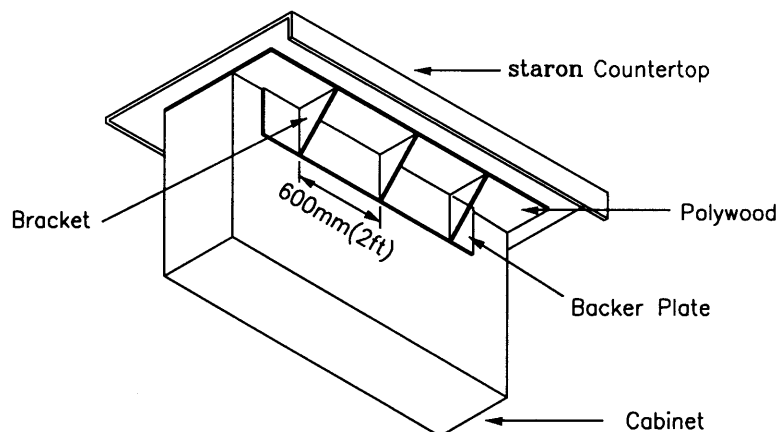



# 9. Support

RZ-801-2014

## Overhang Support

- For 3/4" (20mm) thickness, overhangs of 18" (45cm) or more need to be supported with solid substrate and a leg or column attached to the floor.

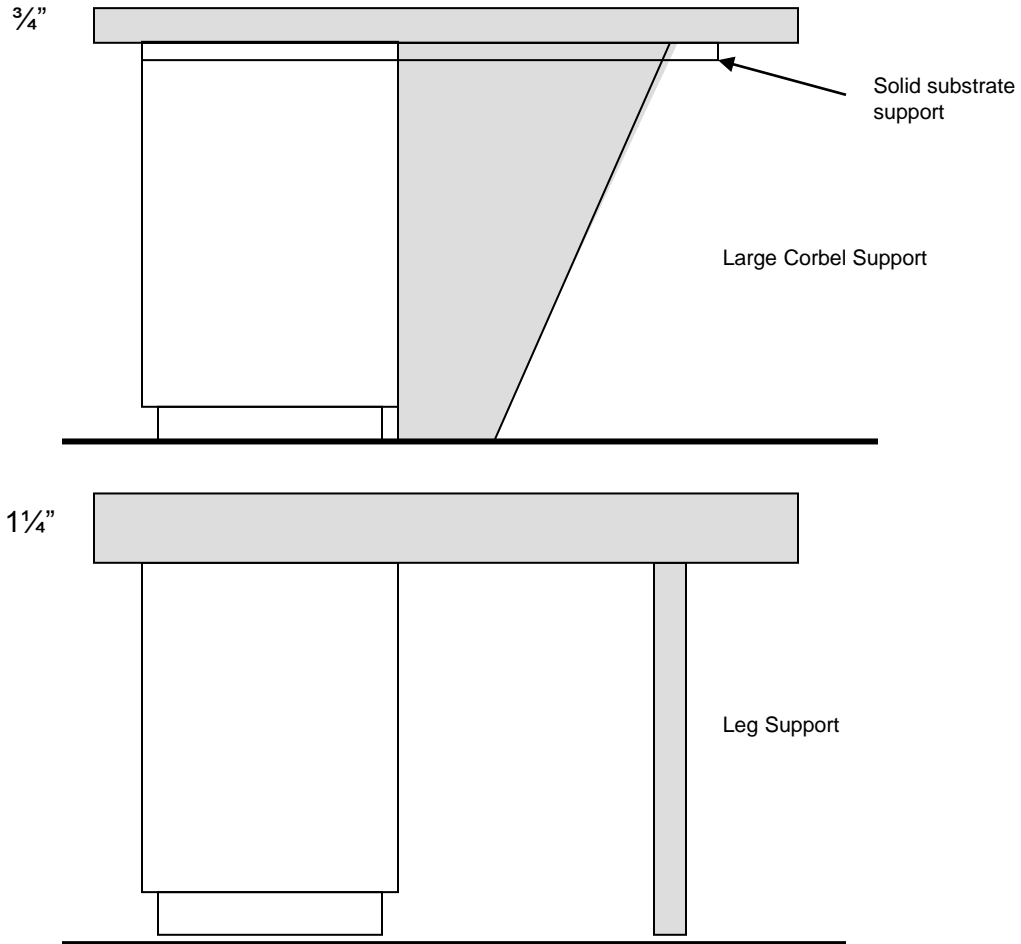

- For 1 1/4"(30mm) thickness, overhangs of 24" (60cm) or more need to be supported with a leg or column.

## 10.1 Introduction

There are different decorative options when selecting backsplashes for Radianz® countertops. Depending on specific decorative needs, customers have the option to choose the backsplash design, material, and decorative finishes.

When working with Radianz® surfaces, there are two backsplash options to choose from.

- Loose backsplash
- Full height backsplash

## 10.2 Loose Backsplash

This is the most common and widely used method. The backsplash is set on the top of the countertop using mainly flexible adhesives or just silicone.

Loose backsplash can be any height. They are generally from 80mm ~ 120mm high and made of  $\frac{3}{4}$ " (20mm) thick Radianz®. Again, all of these could be an open option to the customer's preferences.

For the purpose of decorative feature, loose backsplash usually have 1.5mm radius hand profiled on the top edge for a decorative look. To make the radius, use the wet polisher profiler hand tool.

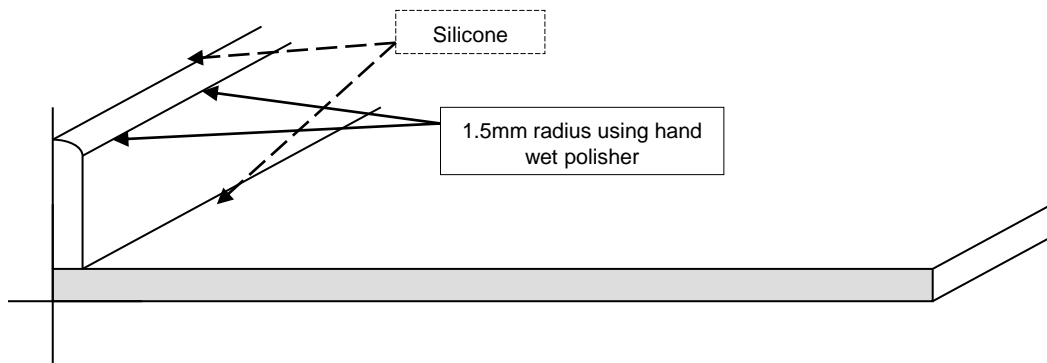

### Installing the backsplash

To install a loose backsplash, run a flexible adhesive on the deck (top) by putting 10mm size dabs on the back of the splash. Use hot glue to help hold the splash in place. Hot glue should be placed between the dabs of adhesive on the back. These dabs of adhesive should be spaced approximately every 300mm.

Set the splash in the adhesive on the deck and push tight to wall and deck of the countertop.

Lay bead of silicone in corner between the top and splash.

Make sure the bead of silicone touches the splash and the top.

### Cleaning

Once the bead of silicone is placed in the corner, spray the bead and material with denatured alcohol.

If the silicone bead does not touch both the splash and the top, the denatured alcohol spray will seep under the splash and the silicone will not stick to either the splash or to the top.

**Tip:** Colored silicon is available to make the top more elegant.

### 10.3 Full Height Backsplash

These splashes run from the top of the counter to the bottom of the upper cabinets.

After the countertop is installed, template the full height backsplash using corrugated plastics template method. Make a template of the wall where the backsplash would be.

Alternatively, you can take measurements but mistakes can easily happen without a template.

Using the corrugated plastic is the best method for the full height backsplash.

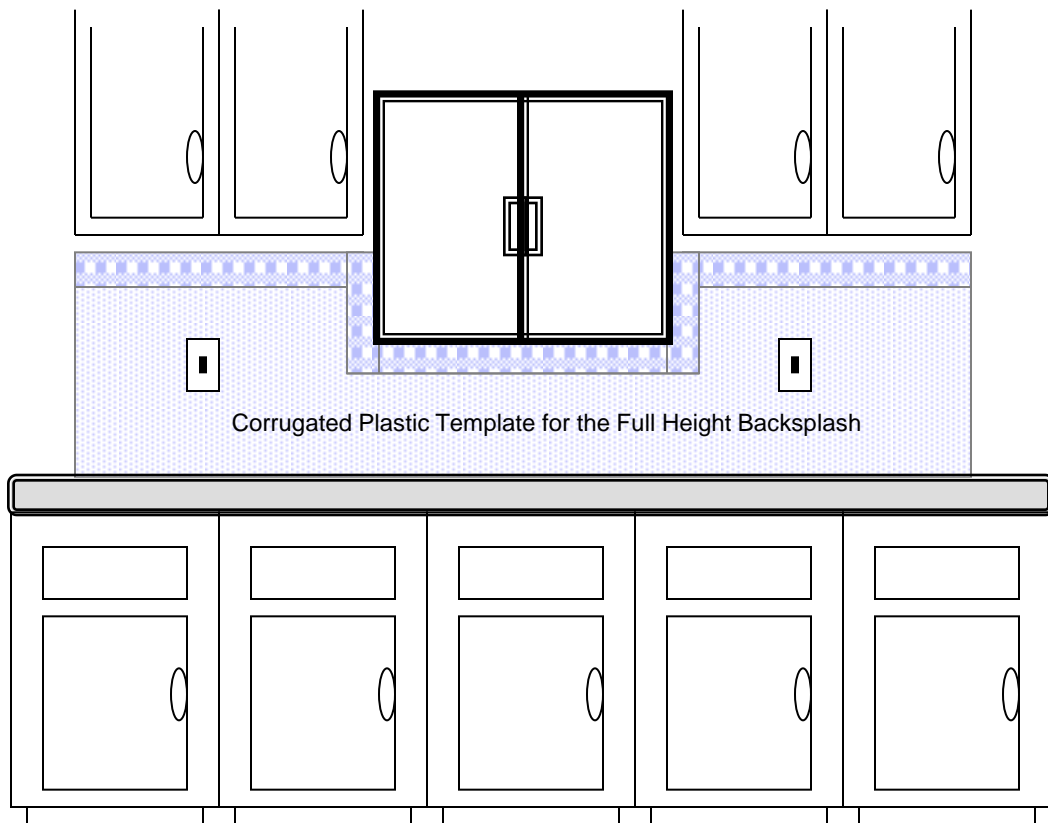

#### Full height backsplash template and fabrication

- Cut the corrugated plastic to 1/8"(3mm) short of overall height and length. If there are different heights, such as under a window or microwave, cut the pieces separately. Make these pieces longer than needed by about 200mm. This will allow for overlapping and gluing.
- Once all the pieces are cut to size, hot glue them together.
- After the pieces are glued, cut 40mm wide strips and hot glue to the template, making sure to butt the cardboard strips to the underside of the upper cabinets. This will give an exact template of the splash.
- Lay the template on the material and trace out. Lay the template flush with the bottom of the material. After tracing is finished, use a core drill bit and grinder to make the required holes for the backsplash.
- After the piece is cut to size, dry fit it into place. Scribe as needed.

## 11.1 Transportation

The best way to transport the Radianz® top is standing up on edge. Always put blankets where the surface is exposed to direct sun light.

Use "A" frame carts with wheel and wheel locks. This method can be used in any kind of truck. Transport materials vertically on A-frames wrapped with carpet, blankets, or proper padding to protect polished faces.

Slab pieces containing cutouts should be supported. In loading, load this piece toward the top of the A-frame to minimize the loading weight on the piece.

Always strap tops to the cart and strap the cart to the truck.

Pictures shown below are some of the available tools to move slabs and pieces.



Rack for easy access & also mountsto a flatbed truck



Equipments available to move quartz surfaces

**Warning:** Never leave any body parts under or near the moving slab.  
Always keep slabs closer to the ground.

## 11.2 Installation Site Preparation

- Check to be sure cabinets are flat to within 3mm. Shim to flat if necessary.
- If the top is installed on uneven cabinets exceeding 3mm, it will be void from the warranty.
- For overhang supports, please refer to the overhang support section.
- Cover all heat and AC vents on the floors or near where the top is being installed. (This will save headaches down the road. Dust will settle in these vents until the customer turns on the heat or AC. The dust from the installation will blow throughout the house and the customer might call and complain.)

**Tip:** The cabinet leveling is the most important. 3mm offset every 3m.

## 11.3 Carrying & Positioning

- **Do not carry the top flat!**
- Always carry the top on edge.
- Use slab dolly and ramps to transport onto site one at a time.
- **Remember to move pieces one at a time!**
- When setting the top in place, pivot slab onto the cabinet edge and slide into place.
- Make sure to have at least two people carrying and setting the top in place. It is important that you work together and slowly.
- Do not get the top twisted or jammed in place. This will cause stress in the top and possibly break.



Carry Clamps

## 11.4 Dry Fitting

### Dry Fitting

- After setting the top in place, examine the fit of all edges
- Shim top as leveling is needed
- Everything should line up
- Scribe the top as needed

### Seaming joints are not acceptable:

- In the middle and above a dishwasher
- In the middle of an undermount sink
- In direct sunlight

## 11.5 Faucet Holes

- Use a standard core bit driller, 1"(25mm) or 3/8"(10mm) wet polisher. (hand tools)
- Must perform the cut in wet condition.

**Note:** Do not twist the drill in the hole.

*This will cause stress in the top and it could break the top. Be careful not to push too hard on the drill. If you push too hard when the hole is almost all the way through, the drill will slam into the deck of the top. This could cause a crack in the top.*

## 11.6 Final Placement

### Final Placement (before seaming)

- Once everything is in place and ready to go, wipe the seam area with denatured alcohol.
- Get the seam adhesive ready to go.

### Seaming the top pieces

- 1) Check and level the countertop again!
- 2) Use painter's tape to tape along both sides of seam within 6mm of seam. (This is for a easy clean up)
- 3) Use the provided color matching adhesive to do the seaming the pieces.
- 4) Pull the seam together with a clamping method you choose.
- 5) Remove excess adhesive off using razor blade.
- 6) Wait for the seam to harden and cure. Let it fully cure!

**Tip:** Leave the site cleaner than you found it. This will go a long way with the customer.  
Install the backsplashes at this time.

## 11.7 Install Backsplash

### Backsplashes

- Outlet boxes must have precision cutting.
- Determine exact locations for the opening to be located.
- Using a turbo blade and grinder, score the front face to outline the finished size.
- Cut from the back side with a 150mm or larger blade and plunge through the front.
- You will have to over-cut on the back to get the desired finished cut-size on the surface.

## 11.8 Do's and Don'ts

### Do's

- Use trivets or hot plates before putting hot pans on the top directly.
- To protect the top, use a cutting board whenever possible.
- Clean with soap and water, using a sponge. (pH neutral, no chemical cleaner)

### Don'ts

- Do not use Comet™ or Ajax™ (anything abrasive) on the top.
- Do not set anything very hot on the top.
- Always use a trivet or hot plate.

RZ-801-2014

## 12.1 Pits and Voids

### Introduction

Simple surface pits and voids can be repaired using this method.

## 12.2 Tools Needed

### Tools needed

- Acetone
- Acrylic flow grade adhesive, hardener, and color paste
- Mixing cup and stick
- Razor blade (many)
- Nitrile gloves and safety glass



Appalachian Umber



## 12.3 Pits and Voids Remove Procedure

### Pits and Voids Remove Procedure

- Put safety glass and nitrile gloves on.
- Clean the repair area with acetone.
- Color match the adhesive so that the color has the same shade as the background to a mixing cup.
- Re-clean the area with acetone
- Pour the color matching adhesive into the void.
- Using razor blades, aligning the blade perpendicular to the surface, make short sharp strokes back and forth until the adhesives are flush with the top. (It is very important to keep changing the blade to make the grinding consistent because the repair area will be a regular top after it is fully cured)

### Tip :

- Use contrast or one of the off shade colors.
- Use acrylic adhesive because it matches the surface finish better than other product
- Change direction of scraping frequently.
- Use multiple razor blades.

## 12.4 Scratch Remove

### Introduction

Polished surface is very sensitive when it encounters a scratch or blemish, it is extremely difficult to remove it and bring the top back to its original shine. The repair should be performed by an expert and done very carefully and patiently to match the original shine.

## 12.5 Scratch Remove Overview

### Scratch Remove Overview

- Be cautious of perfectly flat surface when polishing the surfaces.
- All surfaces are prepared with large production polishers that the new polished top will be very difficult to match the original appearances.
- Must be patient and be patient even more when trying to match the original gloss level of the top.
- The surface polishing would be the most difficult and critical part of whole repair.
- Follow the procedures extremely carefully and practice polishing in shop at least for 10 hours.

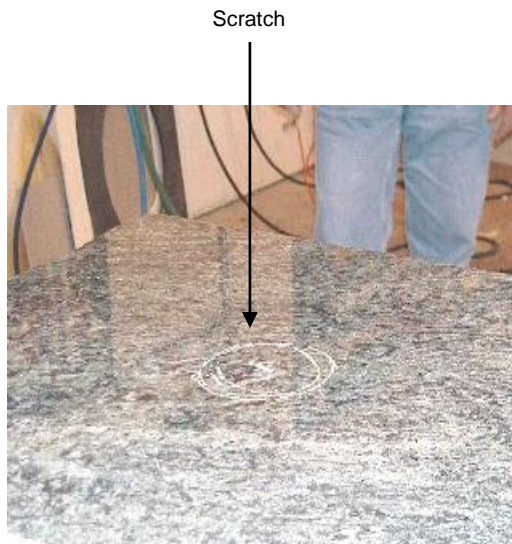

Scratched surface



Scratch removing and polishing

## 12.6 Scratch Remove Procedure

### Scratch Remove Procedures

- To remove a small scratch or blemish, draw a circle with an appropriate marker around the area you wish to work on.
- Use rigid diamond pads on a standard wet polisher. (ex. Alpha Turbo)
- Remember to keep the diamond pad flat and move it in a circular motion.
- Use the highest grit available but make sure it is low enough to remove the existing scratch or blemish.
- Spend long and enough time to remove the problem on the surface.
- Draw another circle that is slightly larger than the previous one in each progress up through the grits. Be sure to work each grit long enough to remove the scratches from the prior grit.
- Use the buff pad thoroughly to blend the surface to match the existing finish.
- Repeat the steps to match the original top.

### Tip :

- Use enough water to cool the surface and the tool because if the surface becomes too hot, the resin will melt and create white areas.
- Surface polishing is so difficult it is an art that is a function of technique, patience, and practice.
- Lots of time will be consumed.
- Dark surface colors in bright light situation are the most difficult ones.
- Expect to spend at least a couple of hours when performing a surface polishing repair.

## 13.1 Care & Maintenance

### Everyday Care

On a routine basis, simply wipe the surface using a clean, soft cloth or sponge with a mild dish-soap diluted in warm water. Polished Radianz® has low porosity and, therefore, does not require the use of a surface sealant and is naturally resistant to surface staining from cooking oils, wine, coffee, etc. In most cases, a mild dish-soap and water is enough to keep your Radianz® looking clean. Afterwards, thoroughly rinse with clean water and dry with soft cloth or paper towels to prevent spotting. For best results, clean liquid spills and dried foods as soon as possible.

### Stubborn Stains and Marks

Apply a non-abrasive household cleaner and rinse to remove residue. For dried liquids, foods and any hardened marks, remove by gently scraping the surface with a plastic putty knife or a non-abrasive Scotch-Brite® pad and then use a damp cloth to lift any residual stains and marks. NEVER use Methylene Chloride or cleaners containing any alkaline materials.

**NOTE :** Scraping by a metal blade on the surface will abrade and leave a gray mark on the surface.

### Preventing Damage

Apply a non-abrasive household cleaner and rinse to remove residue. For dried liquids, foods and any hardened marks, remove by gently scraping the surface with a plastic putty knife or a non-abrasive Scotch-Brite® pad and then use a damp cloth to lift any residual stains and marks. NEVER use Methylene Chloride or cleaners containing any alkaline materials.

#### • HEAT

Although Radianz® is more heat resistant than most surfaces around the home, all stone products can be damaged by sudden and extreme temperature changes, especially near the edges. For this reason, **always use a hot pad or a trivet with rubber feet to protect Radianz®.**

#### • SCRATCHES:

Radianz® is substantially harder than natural stone and is highly resistant to scratching. However, avoid damage by refraining from using knives, screw drivers and other sharp objects directly on the surface. Never cut or chop directly on a Radianz® surface, always use a cutting/chopping board when preparing foods.

#### • CHEMICALS:

- Avoid using cleaners that contain bleach or an abrasive formula.
- Avoid using cleaners that contain Pine Oil – without very thorough rinsing, these products may leave behind a stubborn residue. The pine oil will attract and hold dirt on the surface, eventually reducing the cleanliness of the surface and affecting its appearance.
- Avoid using highly aggressive cleaning agents such as oven/grill cleaners and dishwasher polishing agents that have high alkaline/ pH levels (pH 8.5 or higher).
- Avoid using abrasive scrubs and cleaners that contain either soft or hard abrasive particles.
- Avoid using cleaners that contain xylene, toluene, potassium hydroxide or caustic soda.
- Avoid exposing Radianz® to strong chemicals such as paint removers, furniture strippers containing trichlorethane or methylene chloride.

## 13.2 Removing stains

Radianz™ is stain-resistant, but is not 100% impervious to stain. Many common stains can be removed with proper cleaning. Some colors can be stained by prolonged contact with solution of gentian violet, hair-dye and some lipsticks.

### STAIN REMOVER

Stains \ Remover	Clean water, Neutral detergent	Alcohol
Grease	Yes	-
Coffee	Yes	-
Soft drink	Yes	-
Nail polish	No	Yes
Red wine	Yes	-
Olive oil / Finger mark	Yes	Yes
Rubber mark	- Rub the stain area with a pencil eraser	
Black Tea	AKEMI – Algae & moss remover	
Rust stain	AKEMI – Rust remover	
Water spot	AKEMI - Lime scale remover	
Daily care	AKEMI – Quartz care kit	